

This document is the absolute property of DOMAX Sp. z o.o. This document must not be copied without the written permission of DOMAX Sp. z o.o. The contents thereof must not be disclosed to a third party nor be used for any unauthorized purpose. Contravention will be prosecuted.

Revision				
Rev.	Explanation	Date	Revised by	Approved by

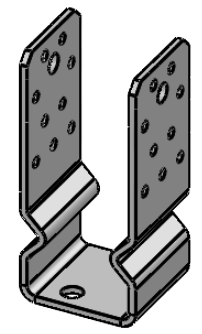
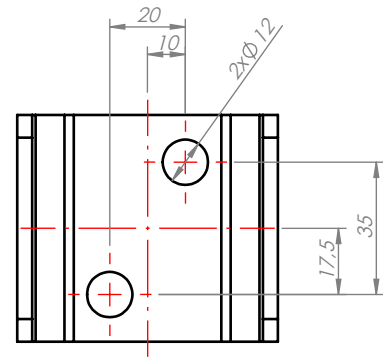
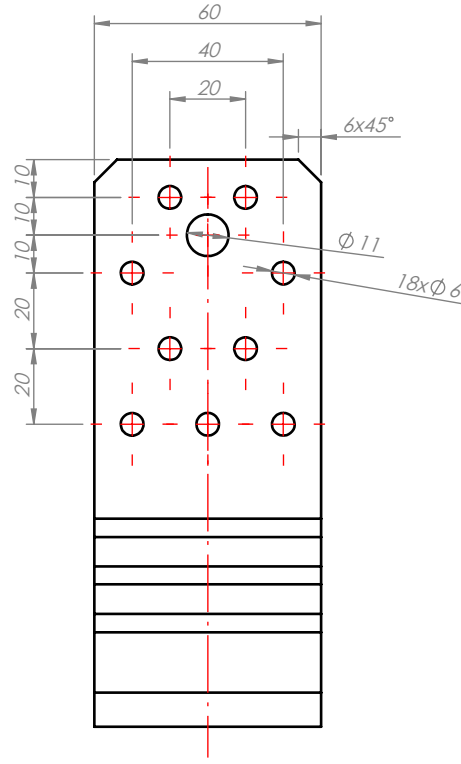
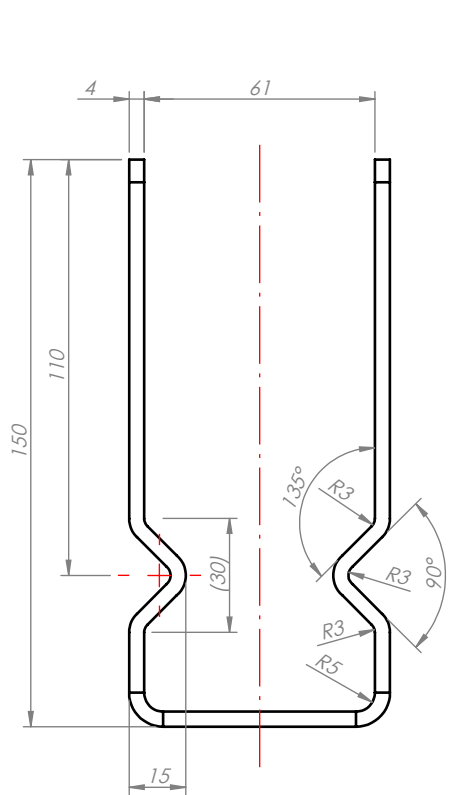

- Note:**
- General tolerances EN 22768 mK.
 - Hot dip galvanized acc to EN ISO 1461.

Design	D. Kozłowski	Checked	-	Approved	-	Note	4.79 dm ²
Drawn	D.Kozłowski	Format	A4	Scale	1:2	Material	S235
Index	480991	Date	20.03.2023	Plate		Weight	0.66 kg
		-		PSSOZ 60		Sheet	1 / 1
DOMAX Sp. z o.o.		-		-		Rev	0